

## FIXED TRACK ROLLING STORAGE – MECH ASSIST



### Features

- Decorative end panels cover exposed side panels – one side only as standard
- Back cover panels cover exposed back panels
- 50 x 20mm steel tracks bolted to the floor
- RUS Shelving bays on fully-welded mobile and static bases
- Units can be DDA Compliant (conditions apply)
- False timber floors recommended for all units – optional
- Ramps available to suit
- Australian designed, engineered and manufactured

### Accessories (available separately)

- Adjustable Slotted Shelf Dividers
- Shelves
- Lateral File Dividers
- Coat Compartments
- Roll Out Suspension File Frames
- Pull Out Multi Media Drawers
- Roll Out Reference Shelf
- Paper Management Units
- A4 or A5 Card Holders

### Technical Specifications

<b>Drive Types</b>	Mechanically Assisted – 300mm Diameter Wheel	<b>Heights</b>	Bay Height: 1980mm - *Overall: 2150mm Bay Height: 2210mm - *Overall: 2380mm
<b>Locking Types</b>	Standard Lock Provision for Padlock 4 Keyed Lock – 6 pin High Security SCEC endorsed B & C Class Security	<b>Widths</b>	Bay Width: 757mm - *Overall: 897mm Bay Width: 909mm - *Overall: 1049mm Bay Width: 1214mm - *Overall: 1354mm Maximum 2 x 1214mm bays wide
<b>End Panel Options</b>	Perforations Laminate Timber Mirrored Graphic Prints	<b>Depths</b>	425mm 458mm 605mm Min depth for single bays are 425mm Bays under 425mm deep must be back to back
<b>Shelves</b>	Shelf heights adjustable in 25mm increments to suit A4 Lever Arch or Lateral Filing Shelf Thickness: 25mm Shelf Loading: 100kg evenly distributed	<b>Overall Unit Lengths</b>	Recommended max. unit length is 9000mm Required min. aisle space is 700mm
<b>Colours</b>	Internal: Off White External: <a href="#">Dulux Powder Coat Colour</a> range (some finishes may attract surcharges)	<b>Weight Loadings</b>	909mm wide bay: 100kg maximum per shelf evenly distributed 1214mm wide bay: 65kg maximum per shelf evenly distributed

\*Overall dimensions include tracks, wheel and end panel on one side only as standard.

**Please allow an additional 50mm clearance on each bay side for installation purposes for overall unit footprint.**

All dimensions are nominal and subject to change without notice. Shelf measurements are based on standard lateral files. Contact CSM to discuss customisable sizes.



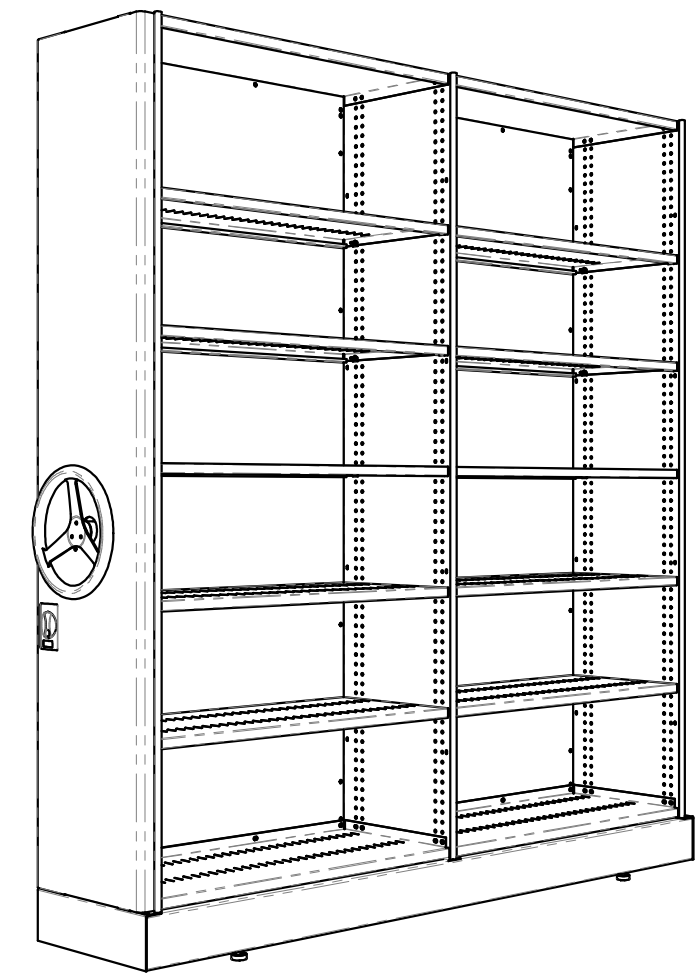
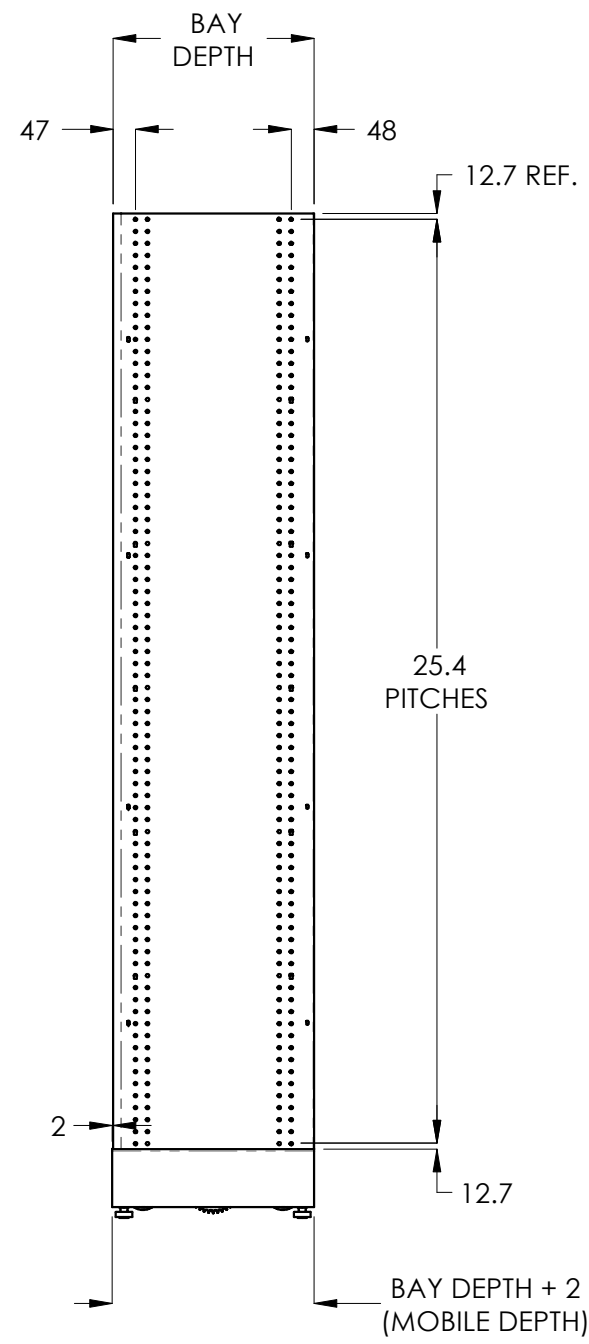
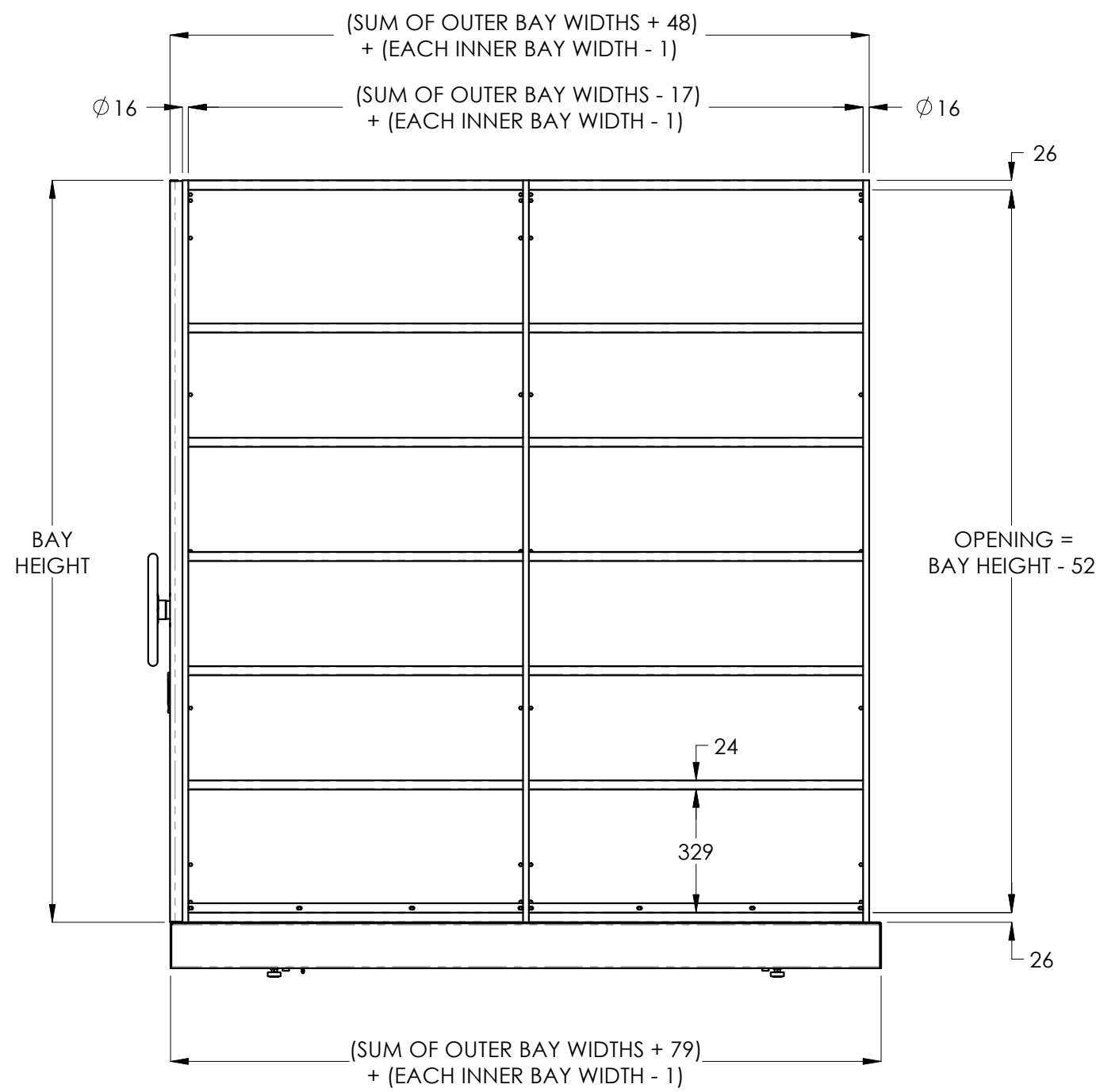

- TYPICAL SINGLE DEPTH MOBILE BAY SHOWN
- ALL DIMENSIONS SHOWN ARE NOMINAL

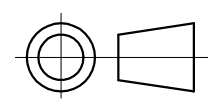
BOOK No. <b>G7</b>	ITEM No. <b>68</b>					 <b>CSM Office Furniture Solutions Pty Ltd</b> 49 Cawarra Road, Caringbah NSW 2229 Australia www.csm-office.com.au	 DO NOT SCALE ALL DIMENSIONS IN MILLIMETRES	PRODUCT: FIXED TRACK ROLLING STORAGE		
								ASSEMBLY NAME: MULTIPLE BAY WIDTH - MECH. ASSIST.		
						PROPRIETARY INFORMATION This drawing remains the property of CSM Office Furniture Solutions Pty Ltd. It must not be reproduced or made available to any third party without prior written consent and must be returned on request. It is not to be used in any unauthorised way.	DRWN: R.DAVIES	DRAWING NUMBER: <b>SA3693</b>	DESIGN TABLE REF. No. .	REV.: <b>A</b>
							DATE: 4.8.11	SCALE: 1:16	SHEET 2 OF 3	SHEET SIZE: A3
		REV.	AMENDMENT	BY	DATE	CAD FILE: SA3693				

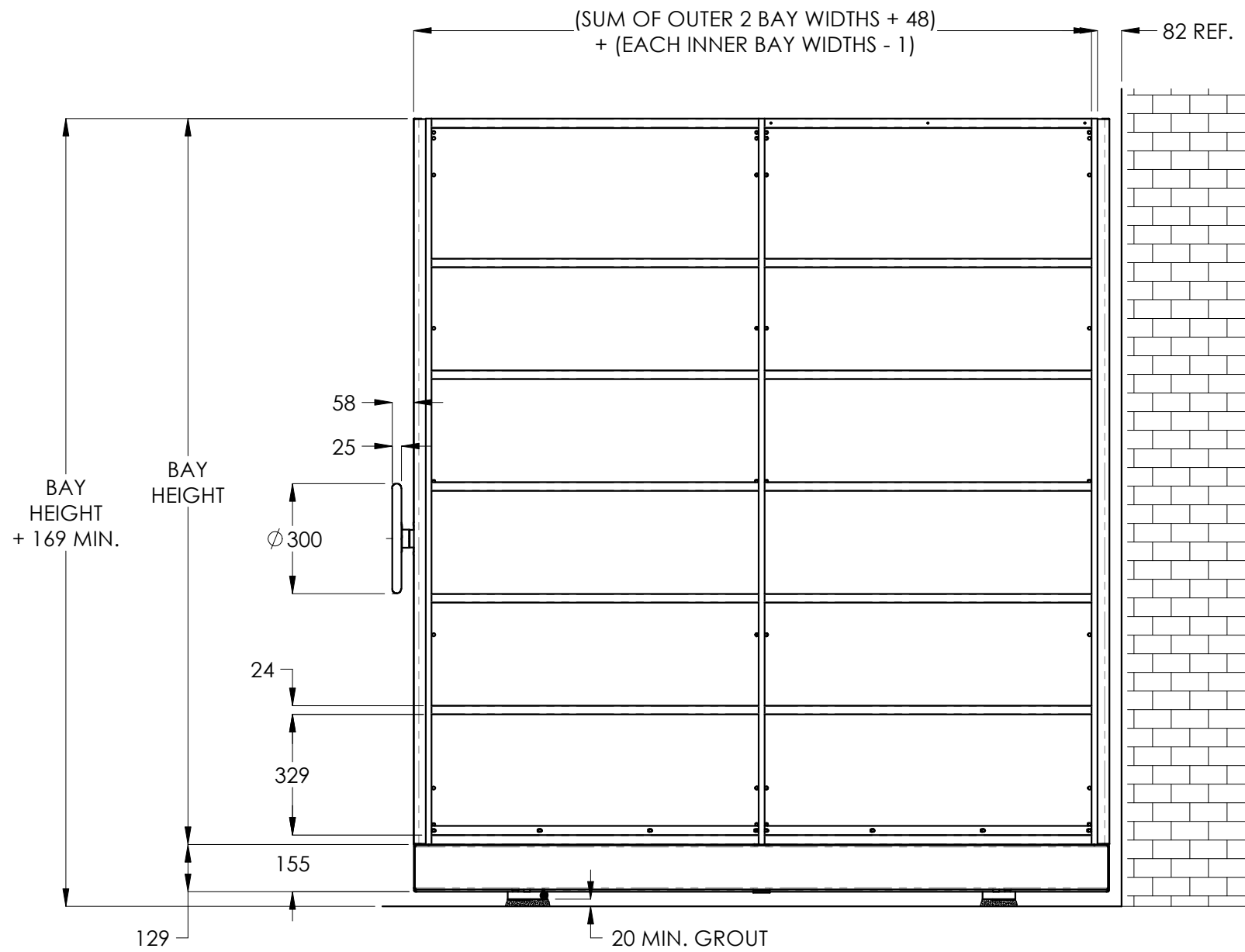

BOOK No.

ITEM No.

**G7**

**68**

REV.	AMENDMENT	BY	DATE



**CSM Office Furniture Solutions Pty Ltd**  
 49 Cawarra Road, Caringbah NSW 2229 Australia  
 www.csm-office.com.au

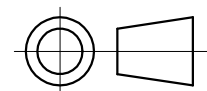

DO NOT SCALE  
 ALL DIMENSIONS IN MILLIMETRES

PROPRIETARY INFORMATION  
 This drawing remains the property of CSM Office Furniture Solutions Pty Ltd.  
 It must not be reproduced or made available to any third party  
 without prior written consent and must be returned on request.  
 It is not to be used in any unauthorised way.

DRWN:  
**R.DAVIES**

DATE:  
**4.8.11**

CAD FILE: SA3693

PRODUCT:  
**FIXED TRACK ROLLING STORAGE**

ASSEMBLY NAME:  
**MULTIPLE BAY WIDTH - MECH. ASSIST.**

DRAWING NUMBER:  
**SA3693**

DESIGN TABLE REF. No.  
 .

REV.:  
**A**

SCALE: 1:16

SHEET 3 OF 3

SHEET SIZE: A3